

High Voltage LED Series Chip on Board

LC040B



High efficacy COB LED package,
well-suited for use in spotlight applications

Features & Benefits

- Chip on Board (COB) solution makes it easy to design in
- Simple assembly reduces manufacturing cost
- Low thermal resistance
- InGaN/GaN MQW LED with long time reliability
- Completed 6,000 hours of LM-80 Testing

Applications

- Spotlight / Downlight
- LED Retrofit Bulbs
- Outdoor Illumination



Table of Contents

1.	Characteristics	-----	3
2.	Product Code Information	-----	6
3.	Typical Characteristics Graphs	-----	13
4.	Outline Drawing & Dimension	-----	18
5.	Reliability Test Items & Conditions	-----	19
6.	Label Structure	-----	20
7.	Packing Structure	-----	22
8.	Precautions in Handling & Use	-----	25

1. Characteristics

a) Absolute Maximum Rating

Item	Symbol	Rating	Unit	Condition
Ambient / Operating Temperature	T_a	-40 ~ +105	°C	-
Storage Temperature	T_{stg}	-40 ~ +120	°C	-
LED Junction Temperature	T_j	150	°C	-
Case Temperature	T_c	105	°C	*Note
Forward Current	I_F	1900	mA	-
Power Dissipation	P_D	70.3	W	-
ESD (HBM)	-	±2	kV	-
ESD (MM)	-	±0.5	kV	-

b) Electro-optical Characteristics ($I_F = 1080 \text{ mA}$, $T_c = 25 \text{ °C}$)

Item	Unit	Rank	Min.	Typ.	Max.
Forward Voltage (V_f)	V	YH	32.5	35.5	38.5
		3	70	-	-
Color Rendering Index (R_a)	-	5	80 ($R_9 > 0$)	-	-
		7	90	-	-
		8	95	-	-
Thermal Resistance (junction to chip point)	°C/W		-	0.8	-
Beam Angle	°		-	115	-
Working Voltage for Insulation	V				50
Nominal Power	W			38.3	

Notes:

- 1) The COB is tested in pulsed condition at rated test current (10 ms pulse width) and rated temperature ($T_j = T_c = T_a = 25 \text{ °C}$)
- 2) Samsung maintains measurement tolerance of: forward voltage = $\pm 5 \%$, CRI = ± 1
- 3) Refer to the derating curve, '3. Typical Characteristics Graph' designed within the range.

c) Luminous Flux Characteristics ($I_F = 1080 \text{ mA}$)

CRI (R_a) Min.	Nominal CCT (K)	Flux Rank	Flux Bin	Sorting ¹⁾ @ $T_c = 25 \text{ }^\circ\text{C}$ (lm)		Calculated Flux ²⁾ @ $T_c = 85 \text{ }^\circ\text{C}$ (lm)		
				Min.	Max.	Min.	Max.	
70	3000	4J	41	4776	5428	4299	4885	
			42	5428	6079	4885	5471	
	4000	4J	41	5063	5753	4557	5178	
			42	5753	6444	5178	5799	
	5000	5J	51	5111	5808	4600	5227	
			52	5808	6505	5227	5854	
	80	2700	4J	42	4050	4400	3686	4004
				43	4400	4750	4004	4323
				44	4750	5100	4323	4641
			4G	45	5100	5450	4641	4960
				44	4750	5100	4323	4641
				45	5100	5450	4641	4960
3000		4J	42	4175	4535	3799	4127	
			43	4535	4895	4127	4454	
			44	4895	5255	4454	4782	
		4G	45	5255	5615	4782	5110	
			44	4895	5255	4454	4782	
			45	5255	5615	4782	5110	
3500	4J	42	4340	4720	3949	4295		
		43	4720	5100	4295	4641		
		44	5100	5480	4641	4987		
	4G	45	5480	5860	4987	5333		
		44	5100	5480	4641	4987		
		45	5480	5860	4987	5333		
80	4000	4J	42	4465	4855	4063	4418	
			43	4855	5245	4418	4773	
			44	5245	5635	4773	5128	
		4G	45	5635	6025	5128	5483	
			44	5245	5635	4773	5128	
			45	5635	6025	5128	5483	
	5000	4J	42	4505	4900	4100	4459	
			43	4900	5295	4459	4818	
			44	5295	5690	4818	5178	
		4G	45	5690	6085	5178	5537	
			44	5295	5690	4818	5178	
			45	5690	6085	5178	5537	
5700	4J	42	4505	4900	4100	4459		
		43	4900	5295	4459	4818		
		44	5295	5690	4818	5178		
	4G	45	5690	6085	5178	5537		
		44	5295	5690	4818	5178		
		45	5690	6085	5178	5537		

c) Luminous Flux Characteristics ($I_F = 1080 \text{ mA}$)

CRI (R_a) Min.	Nominal CCT (K)	Flux Rank	Flux Bin	Sorting ¹⁾ @ $T_c = 25 \text{ }^\circ\text{C}$ (lm)		Calculated Flux ²⁾ @ $T_c = 85 \text{ }^\circ\text{C}$ (lm)	
				Min.	Max.	Min.	Max.
90	2700	4J	42	3465	3795	3154	3454
			43	3795	4126	3454	3754
			44	4126	4456	3754	4055
	3000	4J	42	3536	3873	3218	3524
			43	3873	4210	3524	3831
			44	4210	4546	3831	4137
	3500	4J	42	3642	3989	3314	3630
			43	3989	4336	3630	3946
			44	4336	4683	3946	4261
	4000	4J	42	3748	4105	3411	3736
			43	4105	4462	3736	4061
			44	4462	4819	4061	4386
95	2700	3M	31	3394	3771	3088	3432
			32	3771	4148	3432	3775
	3000	3M	31	3499	3888	3184	3538
			32	3888	4276	3538	3892
	3500	3M	31	3604	4004	3280	3644
			32	4004	4405	3644	4008

Notes:

- 1) The COB is tested in pulsed condition at rated test current (10 ms pulse width) and rated temperature ($T_j = T_c = T_a = 25 \text{ }^\circ\text{C}$)
- 2) Calculated flux values are for reference only
- 3) Samsung maintains measurement tolerance of: luminous flux = $\pm 7 \%$, CRI = ± 1

2. Product Code Information

1	2	3	4	5	6	7	8	9	10	11	12	13	14	15	16	17	18
S	P	H	C	W	1	H	D	N	E	2	5	Y	H	R	T	4	J

Digit	PKG Information	Code	Specification
1 2 3	Samsung Package High Power	SPH	
4 5	Color	WW CW	Warm White (T/U/V/W Ranks) Cool White (Q/R Ranks)
6	Product Version	1	
7 8	Form Factor	HD	COB
9	Lens Type	N	No lens
10	Internal Code	E	LC040
11	Chip Type	2	
12	CRI & Sorting Temperature	3 5 7 8	Min. 70 Min. 80 Min. 90 Min 95 25 °C
13 14	Forward Voltage (V)	YH	32.5~38.5
15	CCT (K)	W V U T R Q	2700 K 3000 K 3500 K 4000 K 5000 K 5700 K WA, WB (MacAdam Ellipse) VA, VB (MacAdam Ellipse) UA, UB (MacAdam Ellipse) TA, TB (MacAdam Ellipse) RA (MacAdam Ellipse) Bin Code: VW, VX, VY, VZ (ANSI bin) TW, TX, TY, TZ (ANSI bin) RW, RX, RY, RZ (ANSI bin) QW, QX, QY, QZ (ANSI bin)
16	MacAdam / ANSI	2 3 T	MacAdam 2-step MacAdam 3-step ANSI bin
17 18	Luminous Flux	3M 4J 4G 5J	31, 32 (95 CRI) Bin Code: 42, 43, 44 (90 CRI); 42, 43, 44, 45 (80 CRI); 41, 42 (70 CRI) 44, 45 (80 CRI) 51, 52 (70 CRI)

a) Binning Structure ($I_F = 1080 \text{ mA}$, $T_c = 25 \text{ }^\circ\text{C}$)

CRI (R_a) Min.	Nominal CCT (K)	Product Code	V_f Rank	Color Rank	Chrom. Bin	Flux Rank	Flux Bin	Flux Range (Φ_v , lm)
70	3000	SPHWW1HDNE23YHVT4J	YH	VT	VW, VX VY, VZ	4J	41	4776 ~ 5428
							42	5428 ~ 6079
	4000	SPHWW1HDNE23YHTT4J	YH	TT	TW, TX TY, TZ	4J	41	5063 ~ 5753
							42	5753 ~ 6444
	5000	SPHCW1HDNE23YHRT5J	YH	RT	RW, RX RY, RZ	5J	51	5111 ~ 5808
							52	5808 ~ 6505
80	2700	SPHWW1HDNE25YHW24J	YH	W2	WB	4J	42	4050 ~ 4400
							43	4400 ~ 4750
							44	4750 ~ 5100
							45	5100 ~ 5450
							42	4050 ~ 4400
							43	4400 ~ 4750
	2700	SPHWW1HDNE25YHW34J	YH	W3	WA, WB	4J	44	4750 ~ 5100
							45	5100 ~ 5450
							44	4750 ~ 5100
							45	5100 ~ 5450
							44	4750 ~ 5100
							45	5100 ~ 5450
	3000	SPHWW1HDNE25YHW24G	YH	W2	WB	4G	44	4750 ~ 5100
							45	5100 ~ 5450
							44	4750 ~ 5100
							45	5100 ~ 5450
							44	4750 ~ 5100
							45	5100 ~ 5450
	3000	SPHWW1HDNE25YHV24J	YH	V2	VB	4J	42	4175 ~ 4535
							43	4535 ~ 4895
							44	4895 ~ 5255
							45	5255 ~ 5615
							42	4175 ~ 4535
							43	4535 ~ 4895
3000	SPHWW1HDNE25YHV34J	YH	V3	VA, VB	4J	44	4895 ~ 5255	
						45	5255 ~ 5615	
						44	4895 ~ 5255	
						45	5255 ~ 5615	
						44	4895 ~ 5255	
						45	5255 ~ 5615	
3000	SPHWW1HDNE25YHV24G	YH	V2	VB	4G	44	4895 ~ 5255	
						45	5255 ~ 5615	
						44	4895 ~ 5255	
						45	5255 ~ 5615	
						44	4895 ~ 5255	
						45	5255 ~ 5615	

a) Binning Structure ($I_F = 1080 \text{ mA}$, $T_c = 25 \text{ }^\circ\text{C}$)

CRI (R _a) Min.	Nominal CCT (K)	Product Code	V _F Rank	Color Rank	Chrom. Bin	Flux Rank	Flux Bin	Flux Range (Φ _v , lm)					
80	3500	SPHWW1HDNE25YHU24J	YH	U2	UB	4J	42	4340 ~ 4720					
							43	4720 ~ 5100					
							44	5100 ~ 5480					
							45	5480 ~ 5860					
		SPHWW1HDNE25YHU34J	YH	U3	UA, UB	4J	42	4340 ~ 4720					
							43	4720 ~ 5100					
							44	5100 ~ 5480					
							45	5480 ~ 5860					
		SPHWW1HDNE25YHU24G	YH	U2	UB	4G	44	5100 ~ 5480					
							45	5480 ~ 5860					
							SPHWW1HDNE25YHU34G	YH	U3	UA, UB	4G	44	5100 ~ 5480
												45	5480 ~ 5860
	4000	SPHWW1HDNE25YHT24J	YH	T2	TB	4J						42	4465 ~ 4855
												43	4855 ~ 5245
							44	5245 ~ 5635					
		SPHWW1HDNE25YHT34J	YH	T3	TA, TB	4J	45	5635 ~ 6025					
							42	4465 ~ 4855					
							43	4855 ~ 5245					
	SPHWW1HDNE25YHT24G	YH	T2	TB	4G	44	5245 ~ 5635						
						45	5635 ~ 6025						
						SPHWW1HDNE25YHT34G	YH	T3	TA, TB	4G	44	5245 ~ 5635	
	45	5635 ~ 6025											
	5000	SPHCW1HDNE25YHR34J	YH	R3	RA						4J	42	4505 ~ 4900
						43	4900 ~ 5295						
44						5295 ~ 5690							
SPHCW1HDNE25YHRT4J		YH	RT	RW, RX RY, RZ	4J	45	5690 ~ 6085						
						42	4505 ~ 4900						
						43	4900 ~ 5295						
SPHCW1HDNE25YHR34G	YH	R3	RA	4G	44	5295 ~ 5690							
					45	5690 ~ 6085							
					SPHCW1HDNE25YHRT4G	YH	RT	RW, RX RY, RZ	4G	44	5295 ~ 5690		
45	5690 ~ 6085												
5700	SPHCW1HDNE25YHQT4J	YH	QT	QW, QX QY, QZ						4J	42	4505 ~ 4900	
					43	4900 ~ 5295							
					44	5295 ~ 5690							
	SPHCW1HDNE25YHQT4G	YH	QT	QW, QX QY, QZ	4G	45	5690 ~ 6085						
						44	5295 ~ 5690						
						45	5690 ~ 6085						

a) Binning Structure ($I_F = 1080 \text{ mA}$, $T_c = 25 \text{ }^\circ\text{C}$)

CRI (R _a) Min.	Nominal CCT (K)	Product Code	V _r Rank	Color Rank	Chrom. Bin	Flux Rank	Flux Bin	Flux Range (Φ_v , lm)
90	2700	SPHWW1HDNE27YHW24J	YH	W2	WB	4J	42	3465 ~ 3795
							43	3795 ~ 4126
							44	4126 ~ 4456
		SPHWW1HDNE27YHW34J	YH	W3	WA, WB	4J	42	3465 ~ 3795
							43	3795 ~ 4126
							44	4126 ~ 4456
	3000	SPHWW1HDNE27YHV24J	YH	V2	VB	4J	42	3536 ~ 3873
							43	3873 ~ 4210
							44	4210 ~ 4546
		SPHWW1HDNE27YHV34J	YH	V3	VA, VB	4J	42	3536 ~ 3873
							43	3873 ~ 4210
							44	4210 ~ 4546
	3500	SPHWW1HDNE27YHU24J	YH	U2	UB	4J	42	3642 ~ 3989
							43	3989 ~ 4336
							44	4336 ~ 4683
		SPHWW1HDNE27YHU34J	YH	U3	UA, UB	4J	42	3642 ~ 3989
							43	3989 ~ 4336
							44	4336 ~ 4683
	4000	SPHWW1HDNE27YHT24J	YH	T2	TB	4J	42	3748 ~ 4105
							43	4105 ~ 4462
							44	4462 ~ 4819
		SPHWW1HDNE27YHT34J	YH	T3	TA, TB	4J	42	3748 ~ 4105
							43	4105 ~ 4462
							44	4462 ~ 4819

a) Binning Structure ($I_F = 1080 \text{ mA}$, $T_c = 25 \text{ }^\circ\text{C}$)

CRI (R _a) Min.	Nominal CCT (K)	Product Code	V _F Rank	Color Rank	Chrom. Bin	Flux Rank	Flux Bin	Flux Range (Φ _v , lm)
95	2700	SPHWW1HDNE28YHW23M	YH	W2	WB	3M	31	3394 ~ 3771
							32	3771 ~ 4148
		SPHWW1HDNE28YHW33M	YH	W3	WA,WB	3M	31	3394 ~ 3771
							32	3771 ~ 4148
	3000	SPHWW1HDNE28YHV23M	YH	V2	VB	3M	31	3499 ~ 3888
							32	3888 ~ 4276
		SPHWW1HDNE28YHV33M	YH	V3	VA,VB	3M	31	3499 ~ 3888
							32	3888 ~ 4276
	3500	SPHWW1HDNE28YHU23M	YH	U2	UB	3M	31	3604 ~ 4004
							32	4004 ~ 4405
		SPHWW1HDNE28YHU33M	YH	U3	UA,UB	3M	31	3604 ~ 4004
							32	4004 ~ 4405

b) Chromaticity Region & Coordinates ($I_F = 1080 \text{ mA}$, $T_a = 25 \text{ }^\circ\text{C}$)

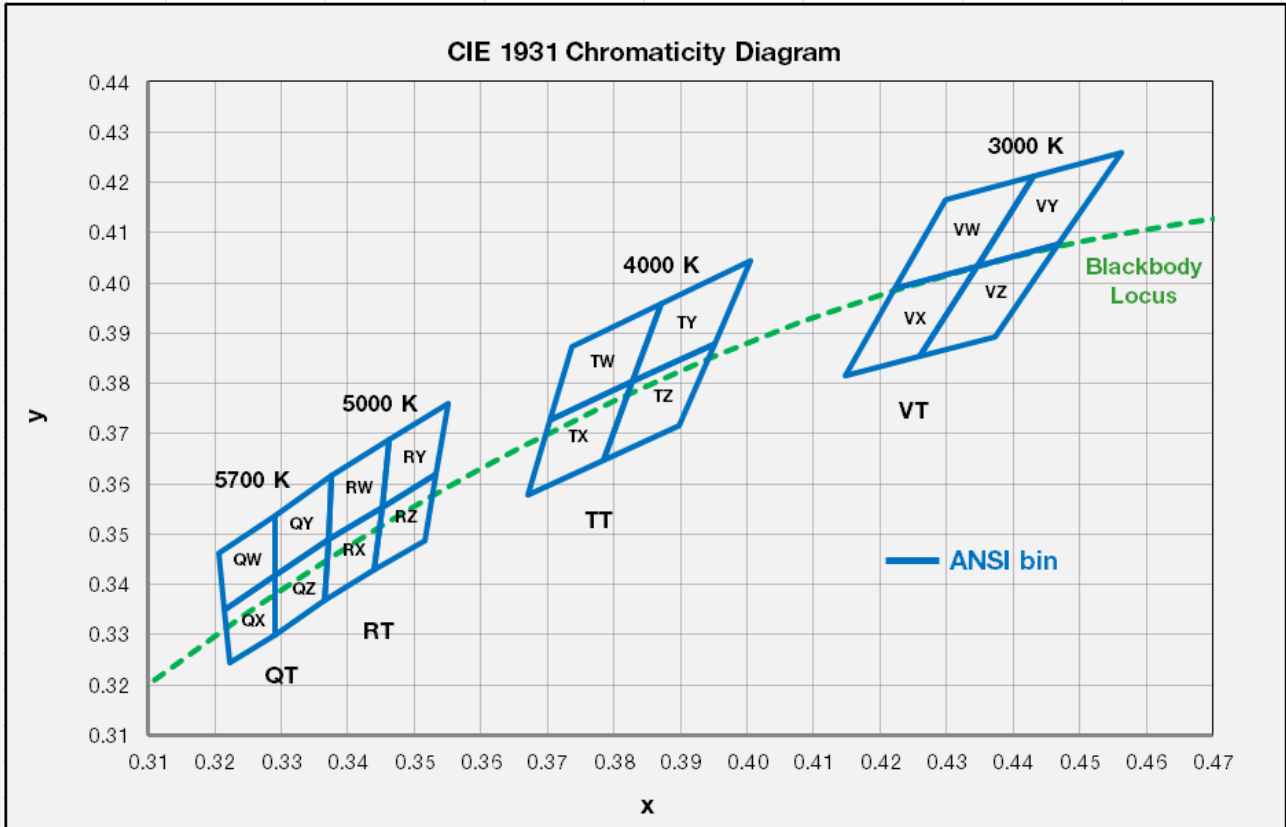

Region	CIE x	CIE y	Region	CIE x	CIE y
V rank (3000 K)					
VW	0.4223	0.399	VY	0.4345	0.4033
	0.4345	0.4033		0.4468	0.4077
	0.4431	0.4213		0.4562	0.4260
	0.4299	0.4165		0.4431	0.4213
VX	0.4223	0.399	VZ	0.4260	0.3854
	0.4147	0.3814		0.4373	0.3893
	0.4260	0.3854		0.4468	0.4077
	0.4345	0.4033		0.4345	0.4033
R rank (5000 K)					
RW	0.3376	0.3616	RY	0.3463	0.3687
	0.3463	0.3687		0.3551	0.3760
	0.3451	0.3554		0.3533	0.3620
	0.3371	0.3490		0.3451	0.3554
RX	0.3371	0.3490	RZ	0.3451	0.3554
	0.3451	0.3554		0.3533	0.3620
	0.3440	0.3428		0.3515	0.3487
	0.3366	0.3369		0.3440	0.3428

Region	CIE x	CIE y	Region	CIE x	CIE y
T rank (4000 K)					
TW	0.3736	0.3874	TY	0.3871	0.3959
	0.3871	0.3959		0.4006	0.4044
	0.3828	0.3803		0.3952	0.388
	0.3703	0.3726		0.3828	0.3803
TX	0.3703	0.3726	TZ	0.3828	0.3803
	0.3828	0.3803		0.3952	0.388
	0.3784	0.3647		0.3898	0.3716
	0.367	0.3578		0.3784	0.3647
Q rank (5700 K)					
QW	0.3207	0.3462	QY	0.3290	0.3538
	0.3290	0.3538		0.3376	0.3616
	0.3290	0.3417		0.3371	0.3490
	0.3215	0.3350		0.3290	0.3417
QX	0.3215	0.3350	QZ	0.3290	0.3417
	0.3290	0.3417		0.3371	0.3490
	0.3290	0.3300		0.3366	0.3369
	0.3222	0.3243		0.3290	0.3300

b) Chromaticity Region & Coordinates ($I_F = 1080 \text{ mA}$, $T_a = 25 \text{ }^\circ\text{C}$)

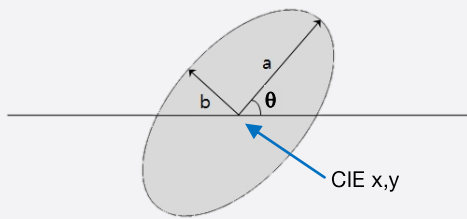
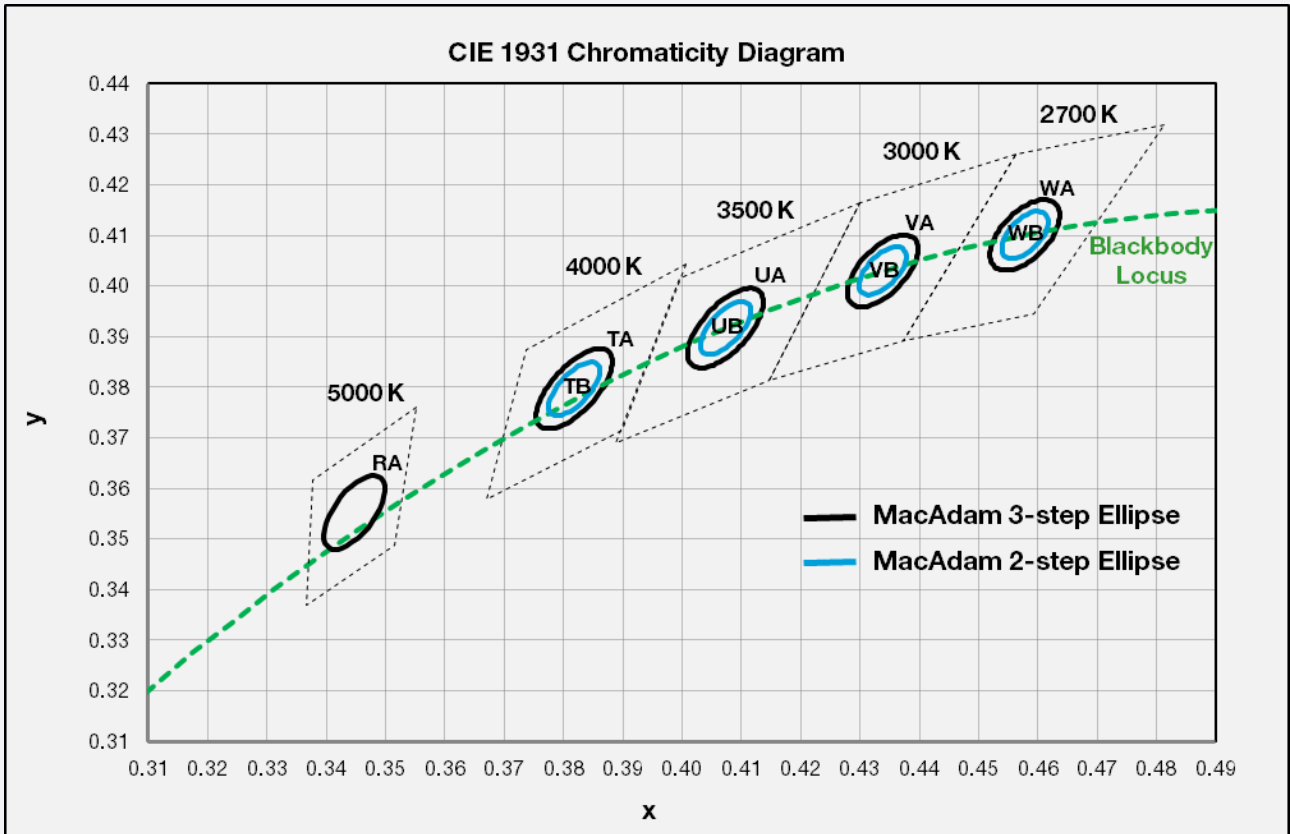

MacAdam Ellipse (WA, WB)					
Step	CIE x	CIE y	θ	a	b
2-step	0.4578	0.4101	53.70	0.0054	0.0028
3-step	0.4578	0.4101	53.70	0.0081	0.0042

MacAdam Ellipse (VA, VB)					
Step	CIE x	CIE y	θ	a	b
2-step	0.4338	0.403	53.22	0.0056	0.0027
3-step	0.4338	0.4030	53.22	0.0083	0.0041

MacAdam Ellipse (UA, UB)					
Step	CIE x	CIE y	θ	a	b
2-step	0.4073	0.3917	54.00	0.0062	0.0028
3-step	0.4073	0.3917	54.00	0.0093	0.0041

MacAdam Ellipse (TA, TB)					
Step	CIE x	CIE y	θ	a	b
2-step	0.3818	0.3797	53.72	0.0063	0.0027
3-step	0.3818	0.3797	53.72	0.0094	0.0040

MacAdam Ellipse (RA)					
Step	CIE x	CIE y	θ	a	b
3-step	0.3447	0.3553	59.62	0.0082	0.0035

Note:

Samsung maintains measurement tolerance of: $C_x, C_y = \pm 0.005$



3. Typical Characteristics Graphs

a) Spectrum Distribution ($I_f = 1080 \text{ mA}$, $T_c = 25^\circ\text{C}$)

CCT: 2700 K (80 CRI)

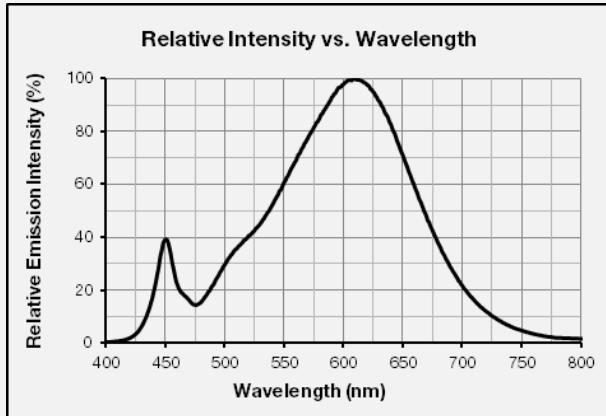

CCT: 3000 K (80 CRI)

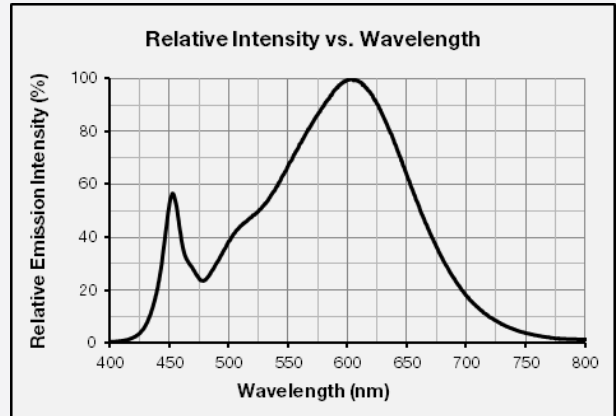

CCT: 3500 K (80 CRI)

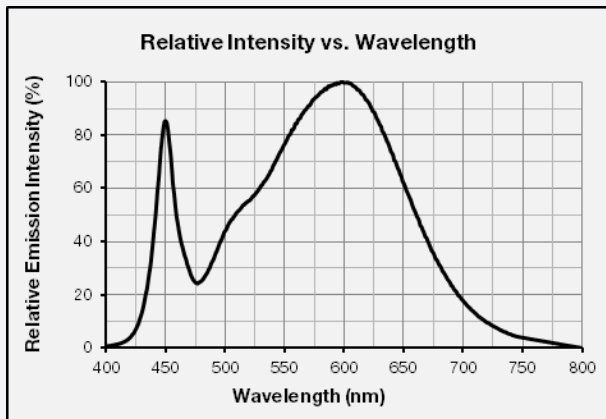

CCT: 4000 K (80 CRI)

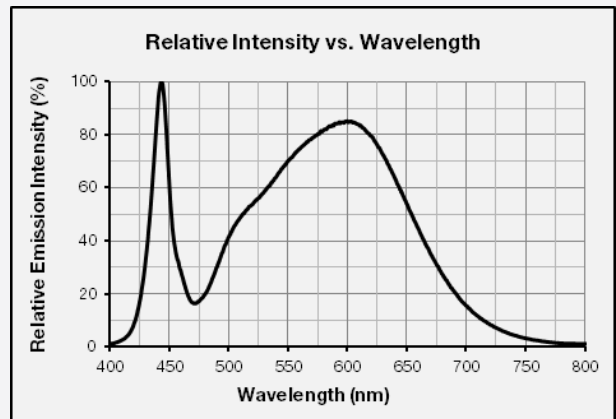

CCT: 5000 K (80 CRI)

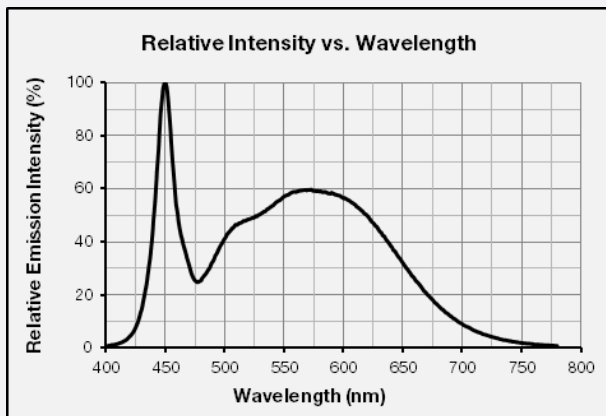

CCT: 5700 K (80 CRI)

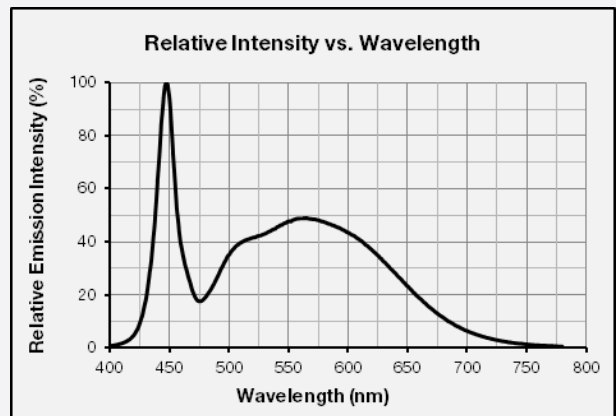

CCT: 2700 K (90 CRI)

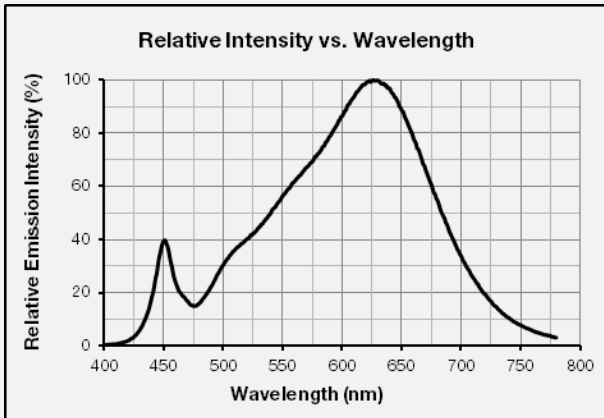

CCT: 3000 K (90 CRI)

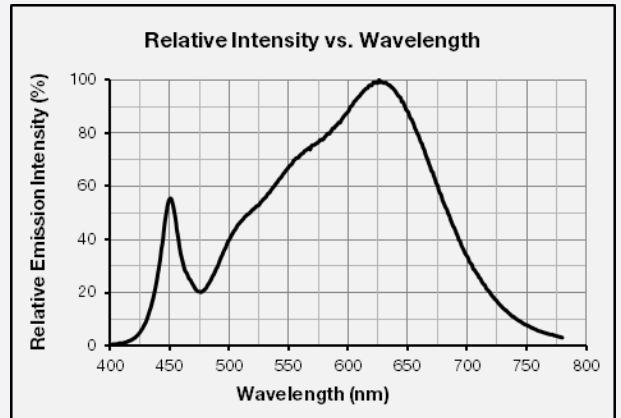

CCT: 3500 K (90 CRI)

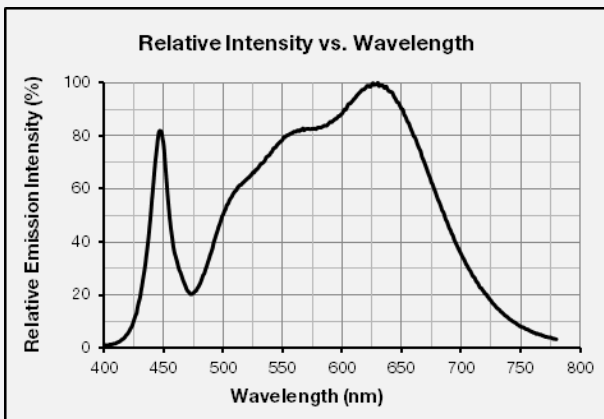

CCT: 4000 K (90 CRI)

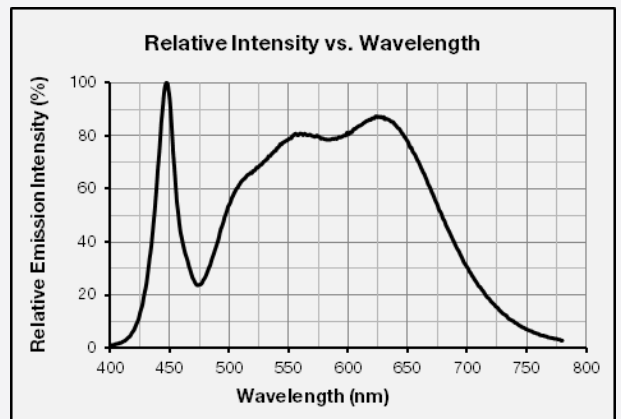

b) Forward Current Characteristics (T_c = 25 °C)

80 CRI

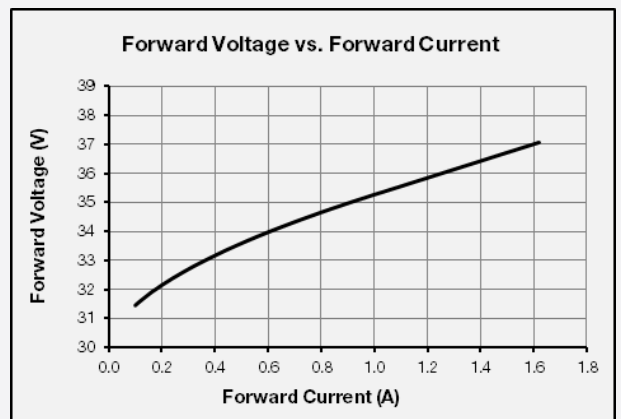
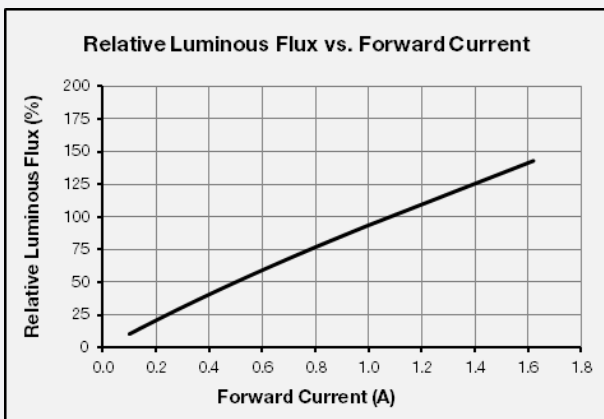

90 CRI

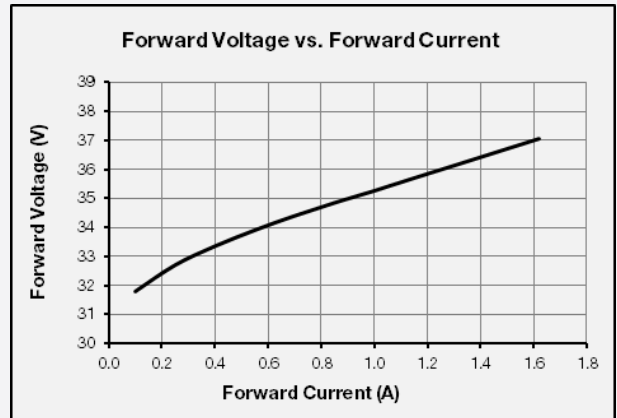
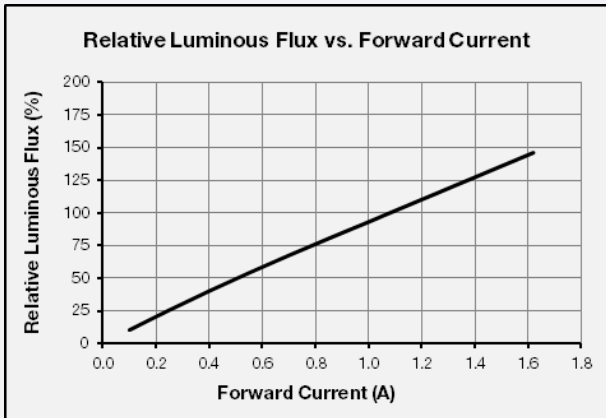

c) Temperature Characteristics ($I_f = 1080 \text{ mA}$)

80 CRI

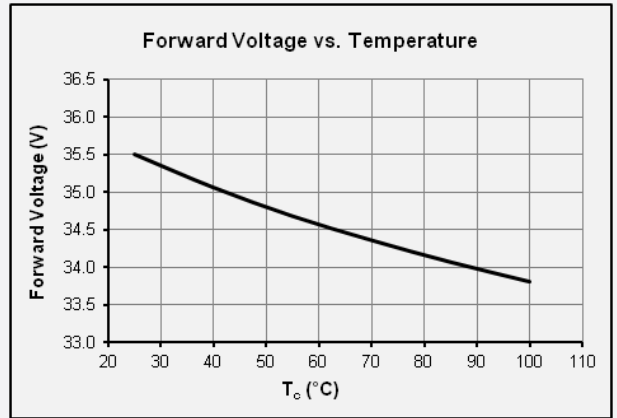
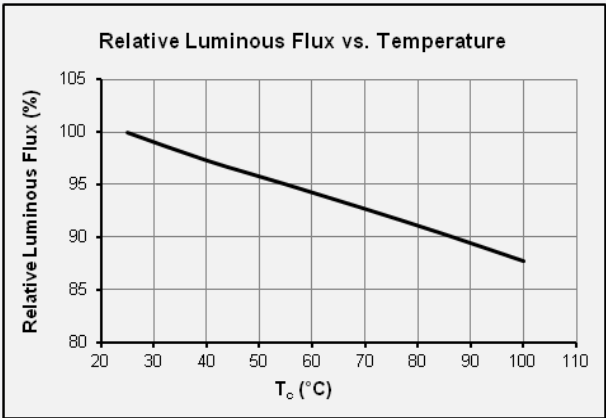

90 CRI

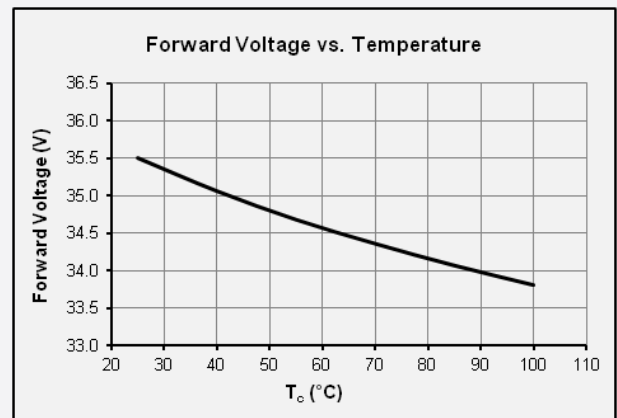
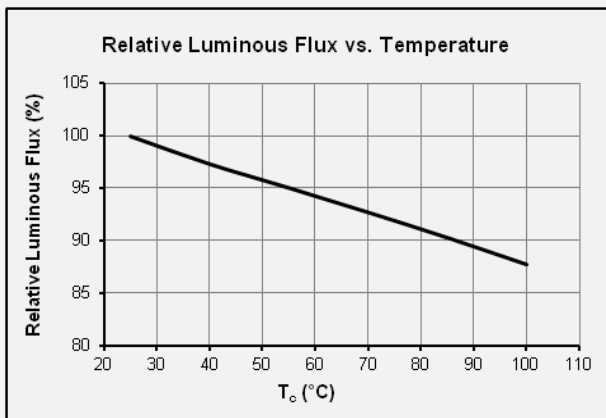

d) Color Shift Characteristics

$T_c = 25^\circ\text{C}$

$I_F = 1080\text{ mA}$

80 CRI

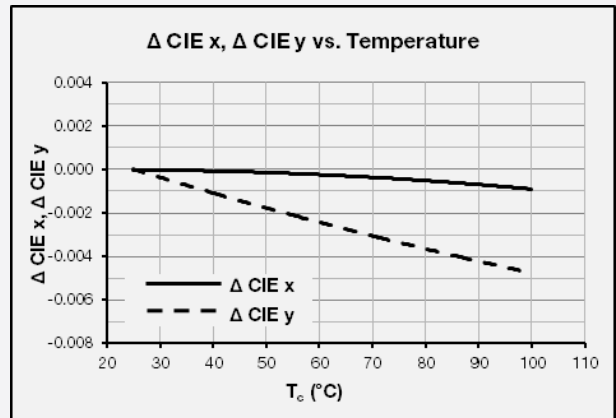
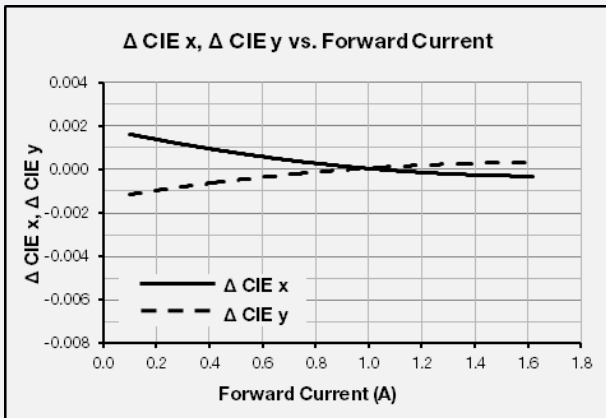

90 CRI

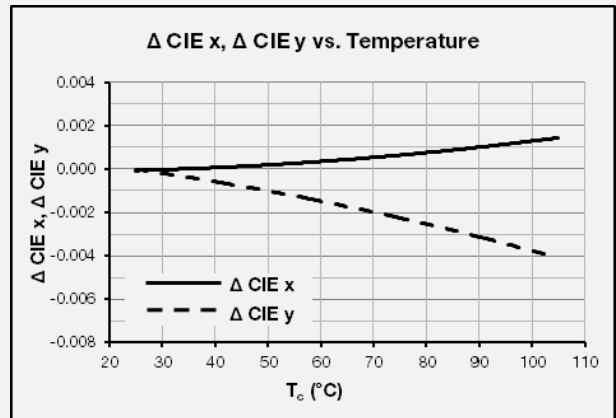
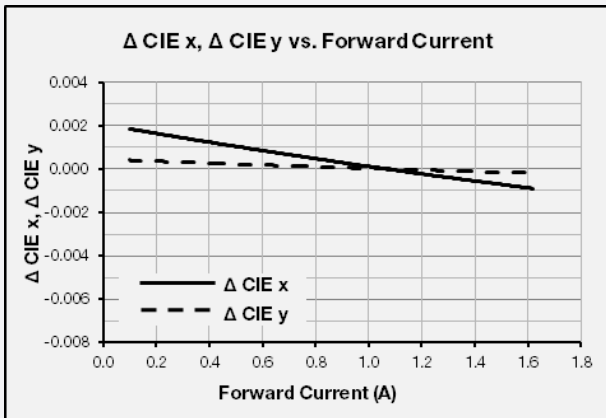

e) Derating Curve

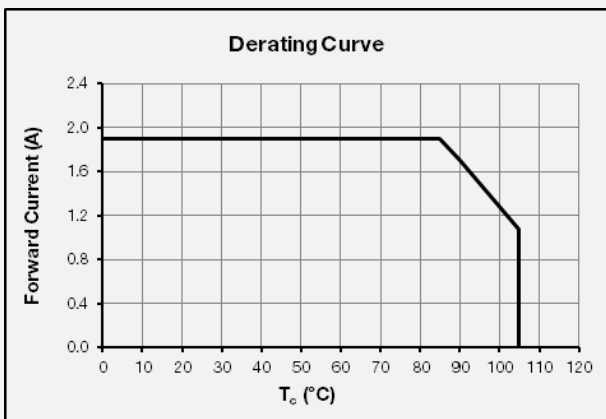

f) Beam Angle Characteristics ($I_F = 1080 \text{ mA}$, $T_c = 25 \text{ }^\circ\text{C}$)

80 CRI

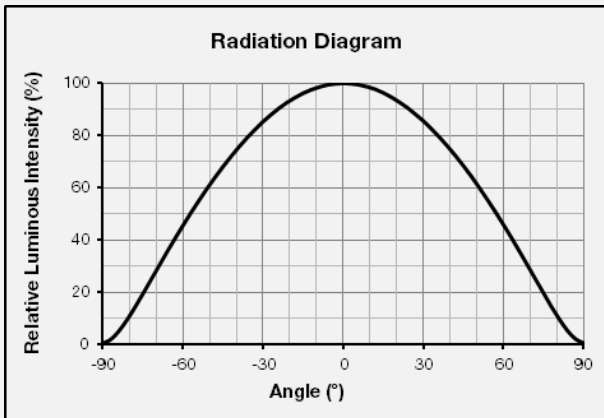

90 CRI

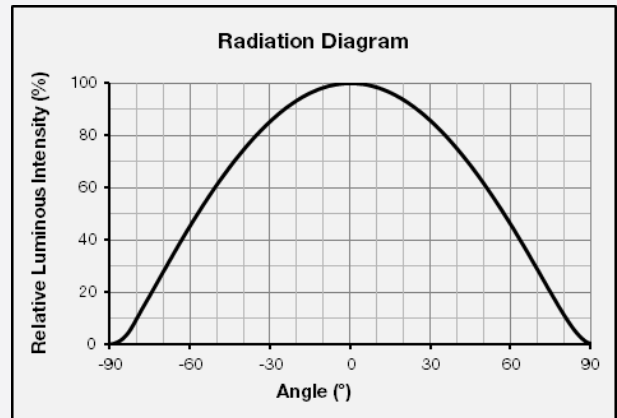

4. Outline Drawing & Dimension

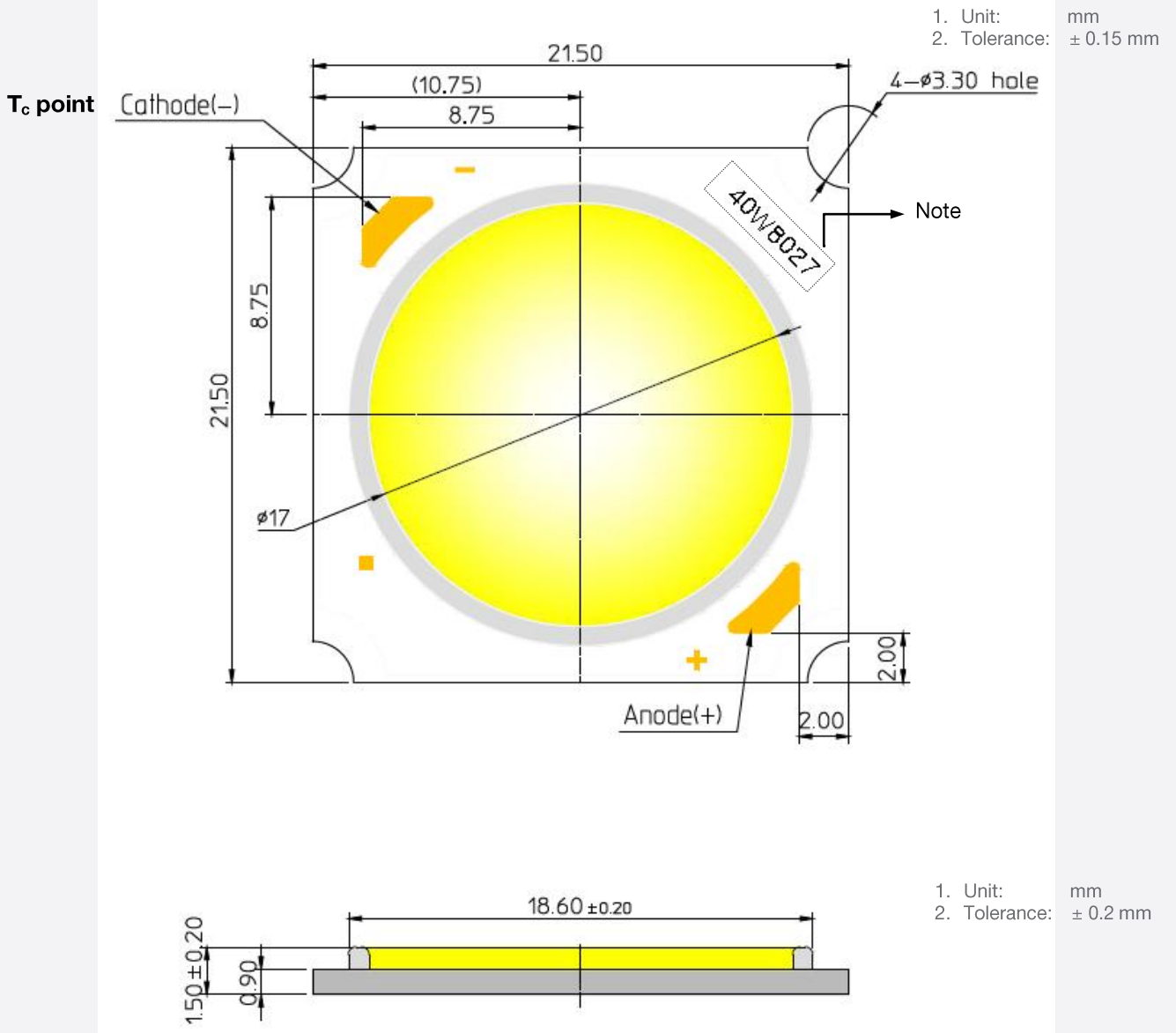

Item	Dimension	Tolerance	Unit
Length	21.50	± 0.15	mm
Width	21.50	± 0.15	mm
Height	1.50	± 0.20	mm
Light Emitting Surface (LES) Diameter	17	± 0.15	mm

Note: Denoted product information above is only an example
(40W8027 : 40W, CRI80+, 2700K)

5. Reliability Test Items & Conditions

a) Test Items

Test Item	Test Condition	Test Hour / Cycle
Room Temperature Life Test	25 °C, $I_F = \text{max}$	1000 h
High Temperature Humidity Life Test	85 °C, 85 % RH, DC Derating, $I_F = \text{max}$	1000 h
High Temperature Life Test	105 °C, DC Derating, $I_F = \text{max}$	1000 h
Low Temperature Life Test	-40 °C, DC 1900 mA	1000 h
High Temperature Storage	120 °C	1000 h
Low Temperature Storage	-40 °C	1000 h
Thermal Shock	-45 °C / 15 min ↔ 125 °C / 15 min temperature change in 5 min	200 cycles
Temperature Cycle On/Off Test	-40 °C / 85 °C each 20 min, 100 min transfer power on/off each 5 min, DC 1080 mA	100 cycles
Temperature Humidity Storage Test	-10 °C ↔ 25 °C, 95 % RH ↔ 85 °C, 95 % RH (24 h / cycle)	100 cycles
ESD (HBM)	R_1 : 10 M Ω R_2 : 1.5 k Ω C: 100 pF V: ± 2 kV	5 times
ESD (MM)	R_1 : 10 M Ω R_2 : 0 k Ω C: 200 pF V: ± 0.5 kV	5 times
Vibration Test	20 ~ 80 Hz (displacement: 0.06 inch, max. 20 g) 80 ~ 2 kHz (max. 20 g) min. frequency ↔ max. frequency 4 min transfer	4 times
Mechanical Shock Test	1500 g, 0.5 ms each of the 6 surfaces (3 axis x 2 sides)	5 times
Salt Spray Test	35 °C, 5 % salt water 8 h spray, 16 h dwell	2 cycles

b) Criteria for Judging the Damage

Item	Symbol	Test Condition ($T_c = 25$ °C)	Limit	
			Min.	Max.
Forward Voltage	V_F	$I_F = 1080$ mA	L.S.L. * 0.9	U.S.L. * 1.1
Luminous Flux	Φ_v	$I_F = 1080$ mA	L.S.L. * 0.7	U.S.L. * 1.3

6. Label Structure

a) Label Structure

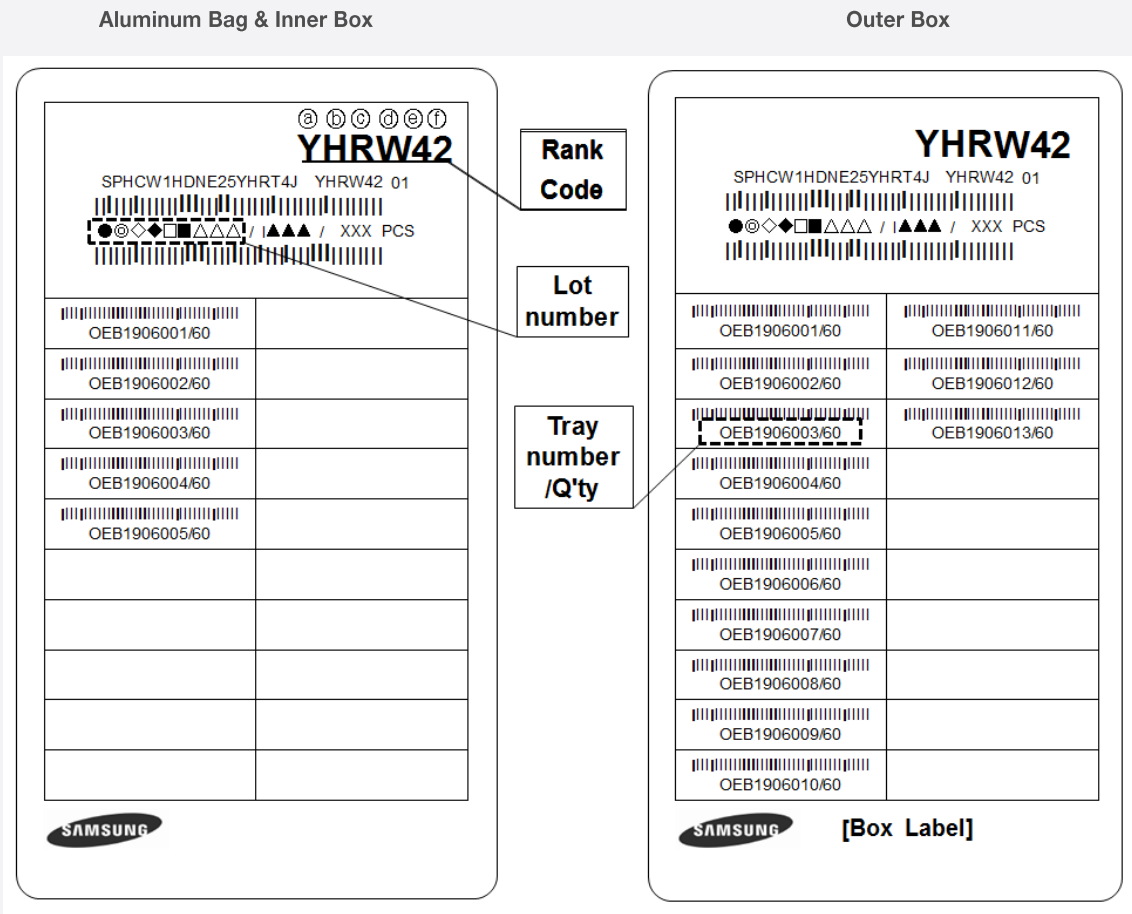

Note: Denoted rank code and product code above is only an example (see description on page 6)

Rank Code:

- ⒶⒷ: Forward Voltage rank (refer to page 7-10)
- ⒸⒹ: Chromaticity bin (refer to page 11-12)
- ⒺⒻ: Luminous Flux bin (refer to page 7-10)

b) Lot Number

The lot number is composed of the following characters:

●◎◇◆□■△△△ / 1▲▲▲ / xxx PCS

- : Production site (S: Giheung, Korea, G: Tianjin, China)
- ◎ : L (LED)
- ◇ : Product state (A: Normal, B: Bulk, C: First Production, R: Reproduction, S: Sample)
- ◆ : Year (Y: 2014, Z: 2015, A: 2016, ...)
- : Month (1~9, A, B, C)
- : Day (1~9, A, B~V)
- △△△ : Product serial number (001 ~ 009)
- ▲▲▲ : Tray number (001 ~ 999)

7. Packing Structure

Packing material	Max. quantity in pcs of COB	Dimension (mm)			
		Length	Width	Height	Tolerance
Tray	60	322.6	135.9	11	0.25
Aluminum Bag	300 (5 trays)	450	230	-	10
PE Foam Pad	-	280	130	10	2
Inner Box	300 (1 aluminum bag)	338	148	55	2
Outer Box	1200 (4 inner boxes)	351	308	120	5
Pallet	67,200 (56 outer boxes)	1000	1000	970	10

a) Packing Structure for 5 trays inside Aluminum Bag

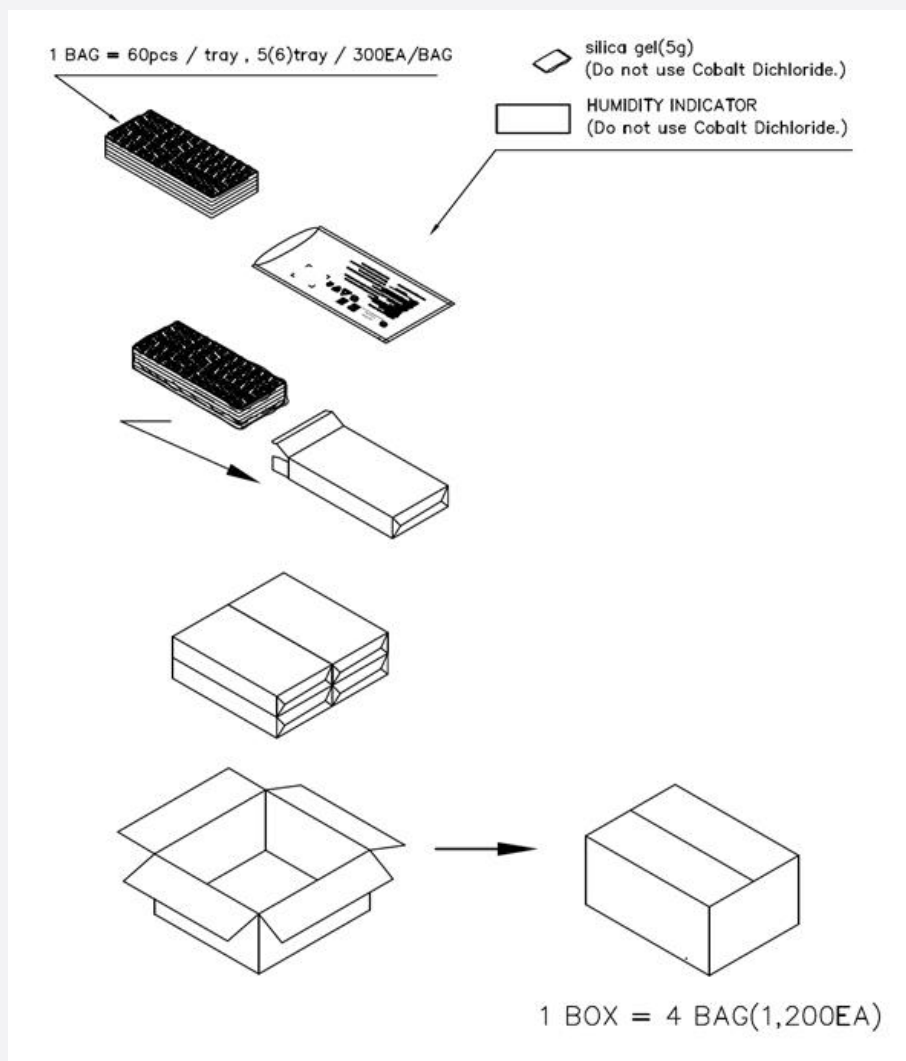

b) Packing Structure for < 5 trays inside Aluminum Bag

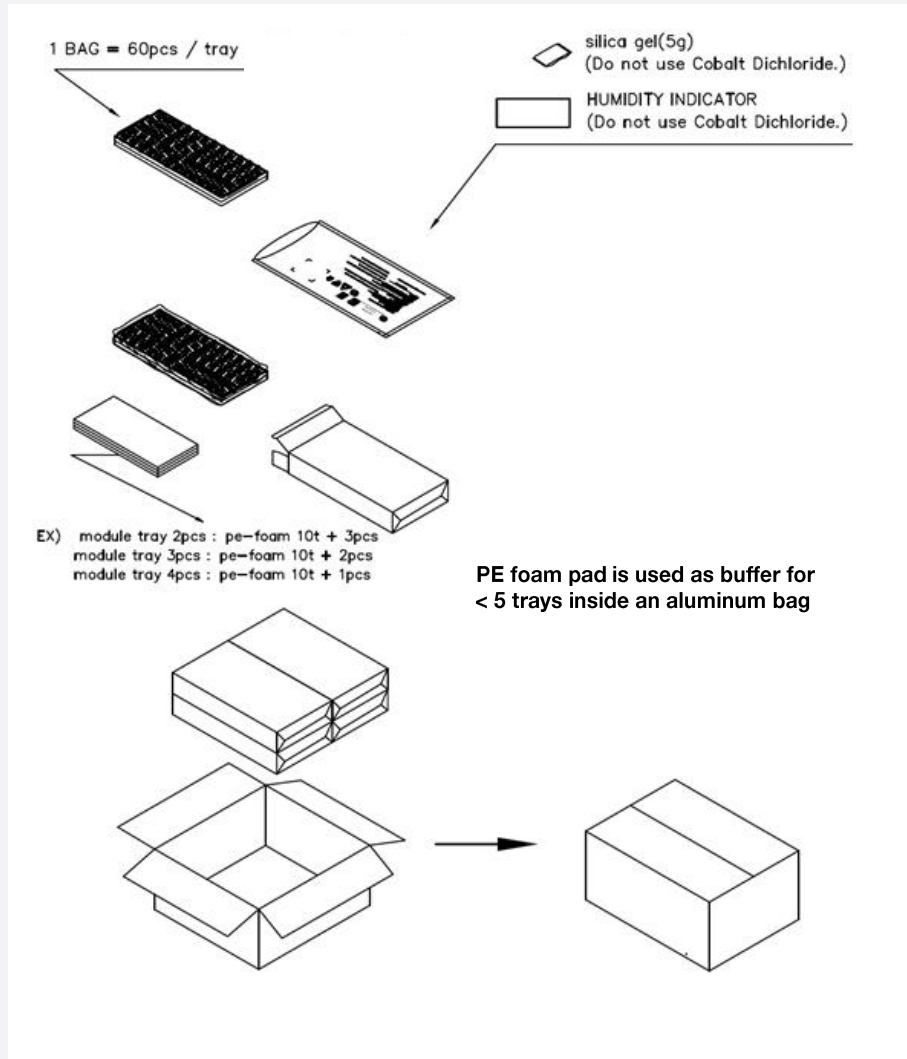

c) Tray

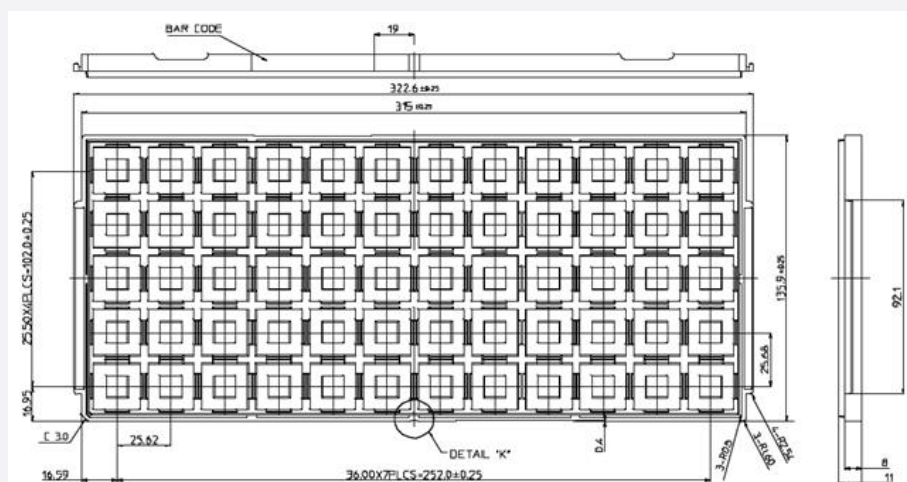

d) Aluminum Vinyl Packing Bag

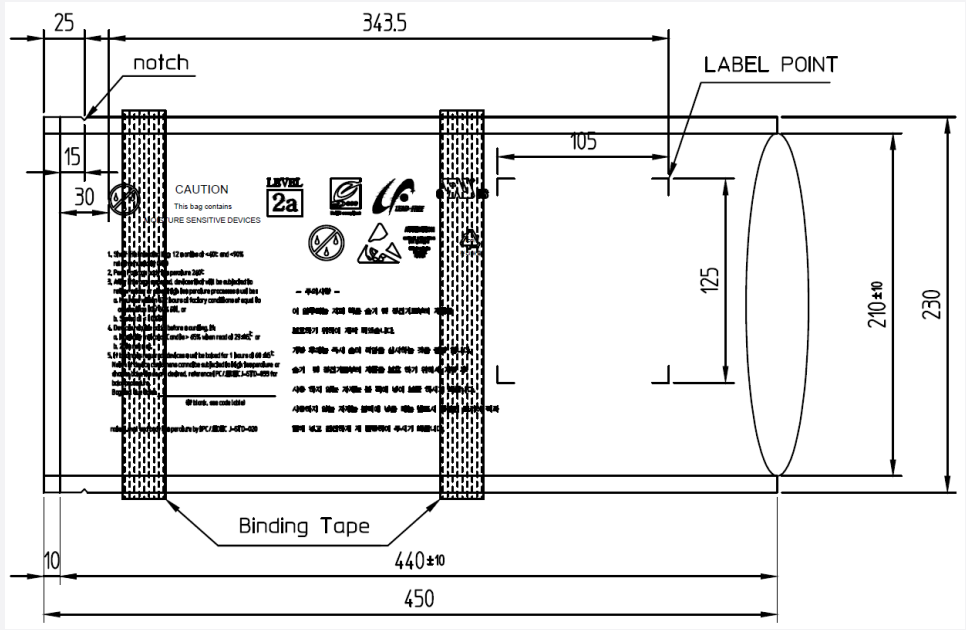

e) Silica Gel & Humidity Indicator Card inside Aluminum Vinyl Packing Bag

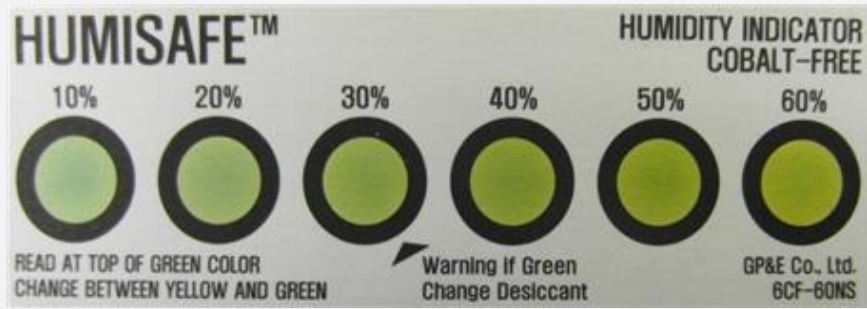

8. Precautions in Handling & Use

- 1) This device should not be used in any type of fluid such as water, oil, organic solvent, etc. When cleaning is required, IPA is recommended as the cleaning agent. Some solvent-based cleaning agent may damage the silicone resins used in the device.
- 2) LEDs must be stored in a clean environment. If the LEDs are to be stored for three months or more after being shipped from Samsung, they should be packed with a nitrogen-filled container (shelf life of sealed bags is 12 months at temperature 0~40 °C, 0~90 % RH).
- 3) After storage bag is opened, device subjected to soldering, solder reflow, or other high temperature processes must be:
 - a. Mounted within 672 hours (28 days) at an assembly line with a condition of no more than 30 °C / 60 % RH, or
 - b. Stored at <10 % RH
- 4) Repack unused products with anti-moisture packing, fold to close any opening and then store in a dry place.
- 5) Devices require baking before mounting, if humidity card reading is >60 % at 23 ± 5 °C.
- 6) Devices must be baked for 1 hour at 60 ± 5 °C, if baking is required.
- 7) The LEDs are sensitive to the static electricity and surge current. It is recommended to use a wrist band or anti-electrostatic glove when handling the LEDs. If voltage exceeding the absolute maximum rating is applied to LEDs, it may cause damage or even destruction to LED devices. Damaged LEDs may show some unusual characteristics such as increase in leakage current, lowered turn-on voltage, or abnormal lighting of LEDs at low current.
- 8) VOCs (Volatile Organic Compounds) can be generated from adhesives, flux, hardener or organic additives used in luminaires (fixtures). Transparent LED silicone encapsulant is permeable to those chemicals and they may lead to a discoloration of encapsulant when they exposed to heat or light. This phenomenon can cause a significant loss of light emitted (output) from the luminaires. In order to prevent these problems, we recommend users to know the physical properties of materials used in luminaires and they must be carefully selected.
- 9) The resin area is very sensitive, please do not handle, press, touch, rub, clean, or pick by with tweezers on it. Instead, please pick at the handling area as indicated below.

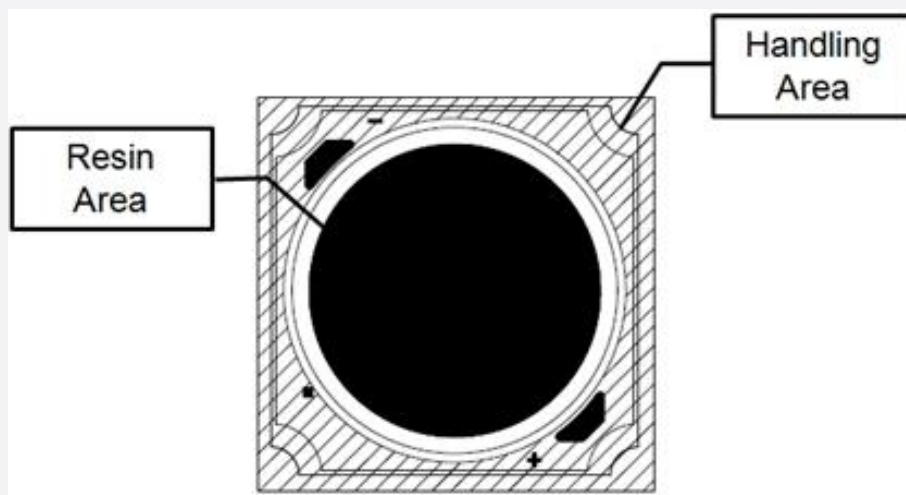

Legal and additional information.

[About Samsung Electronics Co., Ltd.](#)

Samsung Electronics Co., Ltd. inspires the world and shapes the future with transformative ideas and technologies, redefining the worlds of TVs, smartphones, wearable devices, tablets, cameras, digital appliances, printers, medical equipment, network systems and semiconductors.

We are also leading in the Internet of Things space through, among others, our Digital Health and Smart Home initiatives. We employ 307,000 people across 84 countries. To discover more, please visit our official website at www.samsung.com and our official blog at global.samsungtomorrow.com.

Copyright © 2015 Samsung Electronics Co., Ltd. All rights reserved.

Samsung is a registered trademark of Samsung Electronics Co., Ltd.

Specifications and designs are subject to change without notice. Non-metric weights and measurements are approximate. All data were deemed correct at time of creation. Samsung is not liable for errors or omissions. All brand, product, service names and logos are trademarks and/or registered trademarks of their respective owners and are hereby recognized and acknowledged.

Samsung Electronics Co., Ltd.

95, Samsung 2-ro

Giheung-gu

Yongin-si, Gyeonggi-do, 446-711

KOREA

www.samsungled.com

